

Accessories, spare parts and flush buttons 2026

Product range diversity in detail

burda
Sanitärtechnik



















2026

Contents











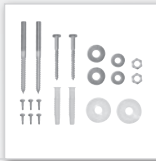

Description	Page
Spare parts and accessories Santro	4
Spare parts and accessories BS+	5
Spare parts and accessories Kombiset und M-Tec	6
Spare parts and accessories Meroblock	7
Spare parts concealed cistern K609	8
Spare parts concealed cistern K610	9
Spare parts concealed cistern K710	10
Spare parts concealed cistern K730	11
Spare parts concealed cistern K750	12
Spare parts concealed cistern K760	13
Spare parts concealed cistern K770	14
Spare parts concealed cistern K921 / K951 / K961	15

Description	Page
Spare parts concealed cistern Geberit Delta (UP100/Basic)	16
Spare parts concealed cistern Geberit Kappa (UP200)	17
Spare parts concealed cistern Geberit Sigma (UP320)	18
Spare parts concealed cistern Geberit Omega	19
Spare parts concealed cistern „Angel1 quantity “ 6 – 9 ltr.	20
Spare parts concealed cistern „Angel 2-quantity“ 3–6 ltr. or 4,5–9 ltr.	21
Spare parts concealed cistern Egea top, front 6 ltr.	22
Spare parts infrared single urinal control, BurdaTronic U-01/U-04 ^(230V)	23
Spare parts urinal control Flowtronik	24
Spare parts urinal trap controls	25
Spare parts urinal flush controls Radar upgrade kit to Flowtronik	26
Spare parts infrared single urinal control, BurdaTronic U-09 ^(230V)	27

Santro drywall element

Description	Ref. no.		Description	Ref. no.	
Santro GKFI building board, core-impregnated, fibre-reinforced gypsum plasterboard. WxHxD: 624 x 1075 x 12,5 mm	697024		Santro wastewater branch, for pre-wall installation on finished floor, Installation height 185 / 220 mm, Branch DN 100 / 80 / 50	550305	
Santro GKFI building board, core-impregnated, fibre-reinforced gypsum plasterboard. WxHxD: 598 x 1300 x 12,5 mm	697000		Santro wastewater branch, for pre-wall installation on finished floor, Installation height 185 / 220 mm, Branch DN 100 / 80 / 100	550404	
Santro construction screws, for GKFI building boards, self-drilling, 100 pieces in a box, for single-layer panelling	697338		Santro connection set, etagiert, DN 80, for height levelling up to 25 mm.	551005	
Santro construction screws, for GKFI building boards, self-drilling, 100 pieces in a box, for double-layer panelling	697345		Santro plastic foot right	551001	
Santro construction screws, 4.8 x 16, self-drilling, for shaft elements, intermediate beams, etc. 100 pieces in a box	697536		Santro plastic foot left	551002	
Santro construction screws, 4.8 x 19, self-drilling, for shaft elements, intermediate beams, etc. 100 pieces in a box	697537		Santro foot spacer right	697057	
Santro wall mounting rail, for continuous mounting of modules etc., 1080 mm	697048		Santro foot spacer left	697058	
Santro WC connection set, DN 80	950080		Santro red fixing clamp (top)	697026	

BS + drywall element

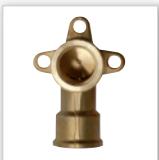
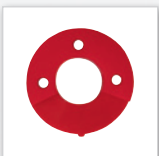
Description	Ref. no.		Description	Ref. no.	
PE-HD drain bend 90/90 for WC, 90° with transition 90/110 suitable for BS+ / M-Tec / Santro	950131		BS+ accessory bag for WC-element	970005	
BS+ wall-hung WC Connection set DN 80	950080		BS+ accessory bag for washstand-element	970006	
BS+ PE drain sheet DN 50, for washstand, with rubber nipple 32 mm, 90°	950026		BS+ accessory bag for urinal-element	970007	
BS+ HT drain sheet, DN 50, 87°	950027		Sealing sleeve for WC-connection elbow DN90HL	214903	
BS+ drain clip for WC-element, ab 2014	970011		Set of prefabricated kits (2 pieces) for shut-off, chrome, matching BS+ element for washbasin, 112 cm for water meter and flush-mounted shut-off valve	960056	
BS+ drain clip for washstand-element	970002		urinal Suction trap Geberit Jet EX, horizontal D 50 mm	960055	
BS+ plastic foot	970008				
BS+ wall disc for washstand / bidet / sink 1/2" internal thread	219011				
BS+ damping disc for fastening wall discs	970004				

Kombiset wet construction element and M-Tec

Description

Ref. no.

Sound insulation mat WC/bidet	550107	
-------------------------------	--------	---

Sound insulation mat washstand	550115	
--------------------------------	--------	---

Sound insulation mat urinal	550120	
-----------------------------	--------	---

Drain clip for Kombiset WC	950110	
----------------------------	--------	--

Drain clip for Kombiset washstand	950115	
-----------------------------------	--------	---

Assembly bag for Kombiset WC	950118	
------------------------------	--------	---

PE-HD drain elbow 90/90, for WC, 90° with transition sleeve 90/110 suitable for Kombiset	950132	
--	--------	---

WC connection set DN 80 185 mm	950080	
--------------------------------	--------	---

PE-connection set, straight 300 mm	950003	
------------------------------------	--------	---

Description

Ref. no.

Carrying supports TS, mounting aid for free-standing installation of Kombiset WC-elements, 1 pair, height 490 mm	550039	
--	--------	---

Carrying supports TSV, as above, but 100 mm longer for barrier-free WC, 1 pair, Höhe 550 mm	550022	
---	--------	---

Carrying supports TSU, mounting aid for free-standing installation of Kombiset urinal-elements, 1 pair, height 950 mm	550046	
---	--------	---

M-Tec

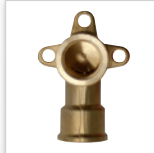
M-Tec wall disc for washstand / bidet / sink 1/2" internal thread	219011	
---	--------	--

M-Tec drain clip	971000	
------------------	--------	---

M-Tec PE drain elbow DN 50, for Washstand, with rubber nipple 32 mm, 90°	950026	
--	--------	---

M-Tec HT drain elbow, DN 50, 87°	950027	
----------------------------------	--------	---

M-Tec extended feet extendable up to 600 mm (pair)	F1000	
--	-------	---

M-Tec Construction kit Pre-wall installation	Z200	
--	------	---

Meroblock

Ref. no.	Description	Ref. no.	
Burda PE-HD WC connection set DN 80, overall length = 200 mm	Z59	Burda assembly covers for washstand and VA with surface-mounted fitting	Z66
Burda AW connection bend DN 50 / 60, cast iron for urinals and sinks	Z42	Burda assembly covers for bidet	Z67
Burda AW connection bend DN 50 / 40, cast iron for washstand und bidet	Z43	Burda assembly covers for sink	Z68
Burda M-Block noise protection cage DN 50 - 100, Length 400 mm	Z400	Seal for PE-HD-AW bend DN 100, for WC (seal for Z21), pack of 10	765049
Burda M-Block noise protection cage DN 50 - 100, Length 1000 mm	Z1000	Lip seal for PE-HD-AW bend DN 50, (seal for Z59) for washstand	765001
Burda M-Block floor connection plate	Z13	Flush pipe DN 45 with lip seal, length = 300 mm, for Meroblock cistern	507435
Burda M-Block pedestal anchor, for free-standing load for WC and bidet	Z06	Universal sealing kit for flush pipe Geberit / Valsir / Schwab / GROHE / Mero	970010
Burda assembly covers for WC	Z02	Universal repair kit incl. flushing pipe bend 300 mm + CV connector DN50	950500
Burda assembly covers for WC barrier-free	Z29	Lip seal for flush pipe Meroblock (PU 10 pcs.)	507111
Burda assembly covers for urinal and VA with concealed fitting	Z65		

Cisterns

Description

Concealed cistern K609
Actuation from the front



Suitable flush buttons:



Ref. no.

1	Burda drain cover complete	960001
2	Burda drain valve seal	960002
3	Burda basin with seal	960005
4	Burda lever bearing	960007
5	Burda lever handle bolt (2 pcs.)	960008
6	Burda filling valve for K609	960009
7	Burda filling valve hose	960010
8	Burda angle valve 1/2" with connection fitting	960011
9	Burda quick-release bolt	960012
10	Burda universal sealing set for flush pipe bend	970010
11	Burda inspection plate incl. lever bolt	960013
12	Burda filling valve holder	960024
13	Burda flush button T901, white	901.00
14	Burda flush button T902, white	902.00

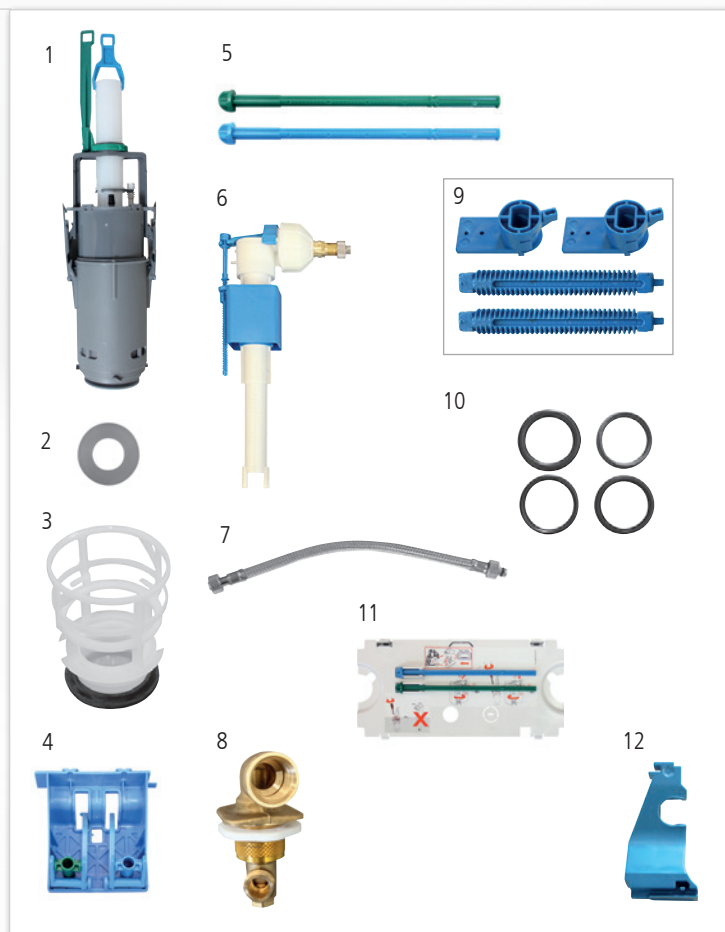

Cisterns

Description

Concealed cistern K610
Actuation from the front



Suitable flush buttons:

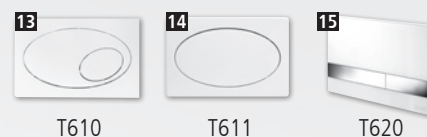

Ref. no.

1	Burda drain cover 2.0 complete	961030
1b	Burda basin with seal up to 12/2015	961005
1c	Burda drain cover up to 12/2015	961001
2	Burda drain valve seal	961002
3	Burda lever bearing	961007
4	Burda lever handle bolt (2 pcs.)	961008
5	Burda filling valve for K 610	961009
6	Burda filling valve hose	961010
7	Burda angle valve 1/2" with connection fitting	961011
8	Burda quick-release bolt	961012
9	Burda universal sealing set for flush pipe bend	970010
10	Burda filling valve holder	961027
11	Burda baffle insert for K610 / K760 / K770	935011
12	Burda inspection plate incl. lever bolt	961013
13	Burda flush button T610	
	white	610.00
	matt chrome finish	610.50
	polished chrome finish	610.51
14	Burda Betätigungstaste T611	
	white	611.00
	matt chrome finish	611.50
	polished chrome finish	611.51
15	Burda Betätigungstaste T620	
	white	620.00
	matt / matt chrome finish	620.50
	polished / polished chrome finish	620.51
	white / matt chrome finish	620.69
	white / polished chrome finish	620.70

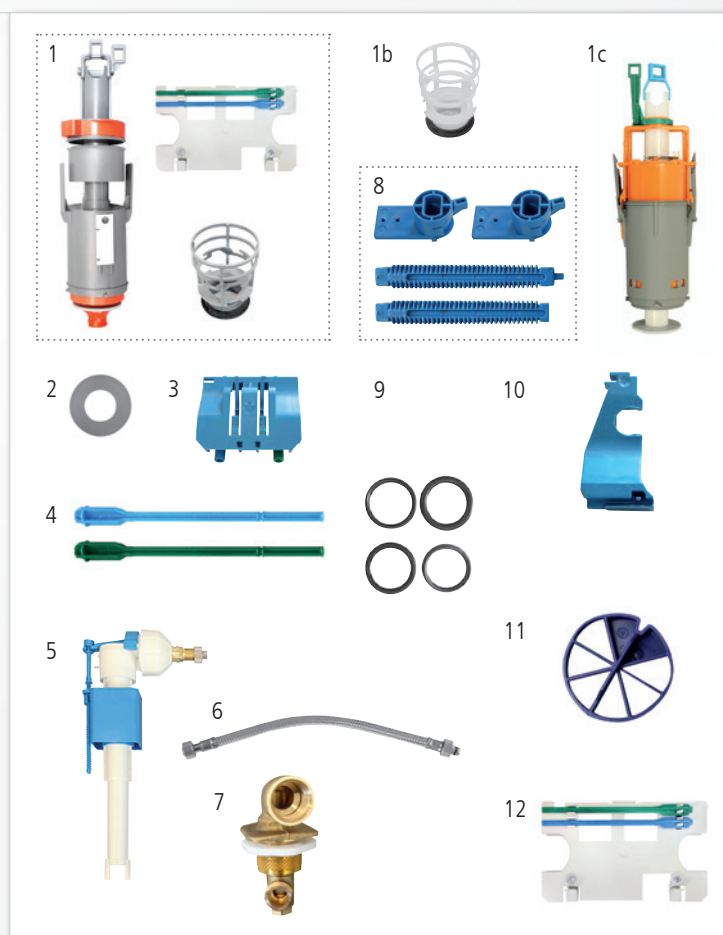

Cisterns

Description

Concealed cistern K710 Flush/stop
Actuation from the front



Suitable flush buttons:



Ref. no.

1	Burda waste valve	933004
2	Burda drain valve seal	932016
3	Burda basin with seal	932010
4	Burda centre block incl. filling valve holder and operating lever	932017
5	Burda water level stick	932005
6	Burda mounting for Burda water level stick	932001
7	Burda filling valve hose	932002
8	Burda filling valve	933005
9	Burda universal sealing kit for flush pipe bend	970010
10	Burda quick bolt fastener	932018
11	Burda fixing clips (2 pcs.)	932015
12	Burda hook for removing from the basin	504640
13	Burda revision plate	933003
14	Burda flush button T710, white	710.00

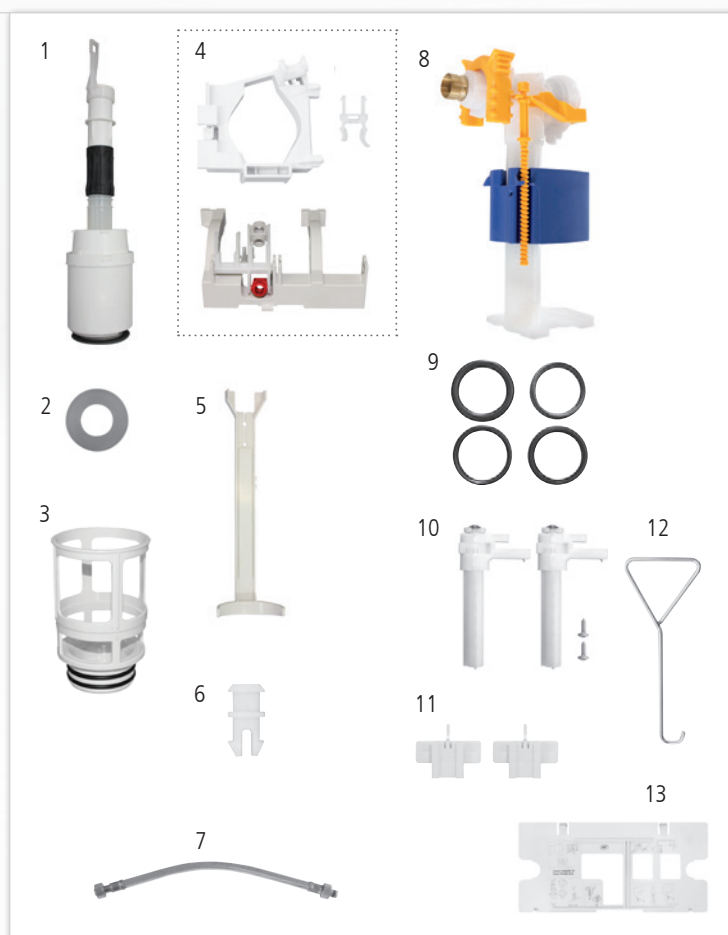

Cisterns

Description

Concealed cistern K730 Dual-quantity technology
Actuation from the front



Suitable flush buttons:



Ref. no.

1	Burda drain valve complete incl. basin and water level stick	932019
2	Burda drain valve seal	932016
3	Burda centre block incl. filling valve holder and operating lever	932017
4	Burda mounting for Burda water level stick	932001
5	Burda filling valve hose	932002
6	Burda filling valve	932014
7	Burda universal sealing kit for flush pipe bend	970010
8	Burda quick bolt fastener	932018
9	Burda fixing clips (2 pcs.)	932015
10	Burda hook for removing from the basin	504640
11	Burda Revisionsplatte	932011
12	Burda flush button T730, white	730.00



Cisterns

Description

Concealed cistern K750
Actuation from the front



Suitable flush buttons:



Ref. no.

1	Burda drain valve complete	934100
2	Burda drain valve seal	930021
3	Burda bearing block incl. spacer	934016
4	Burda construction protection	934008
5	Burda angle valve	935009
6	Burda revision plate	934006
7	Burda filling valve hose	934002
8	Bolt quick-release fastener and lever handle bolt	934013
9	Burda filling valve	934009
10	Burda filling valve holder	934001
11	Burda universal sealing kit for flush pipe bend	970010
12	Burda hook for removing from the basin	
13	Burda eccentric fastening for spacer bolts (2 pcs.)	
14	Burda flush button T753	
	white	
	matt chrome finish	753.50
	polished chrome finish	753.51
15	Burda flush button T760	
	white	
	matt chrome finish	760.00
	polished chrome finish	760.51
16	Burda flush button T770	
	white	
	matt chrome finish	770.00
	hochglanz verchromt	770.51
17	Burda flush button T780	
	polished chrome finish	780.51

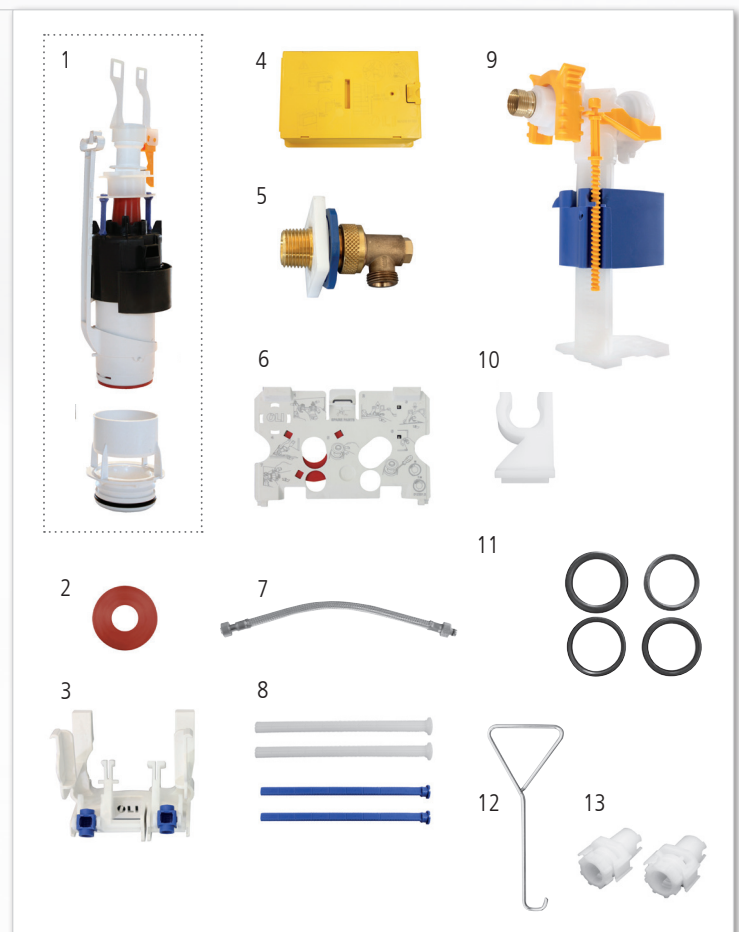

Cisterns

Description

Concealed cistern K760 Actuation from the front



Suitable flush buttons for K760:



Ref. no.

1	Burda drain valve incl. basin and hold-down device	935014
2	Burda drain valve seal	935002
3	Burda bearing block	935004
4	Burda construction protection	935006
5	Burda filling valve hose	935007
6	Burda filling valve with holder	935008
7	Burda angle valve	935009
8	Burda universal sealing kit for flush pipe bend	970010
9	Bolt quick-release fastener and lever handle bolt	934013
10	Burda filling valve holder	935005
11	Burda stowage insert for K760 / K770	935011
12	Burda flush button T760 white matt chrome finish polished chrome finish	760.00 760.50 760.51
13	Burda flush button T770 white matt chrome finish polished chrome finish	770.00 770.50 770.51
14	Burda flush button T780 polished chrome finish	780.51

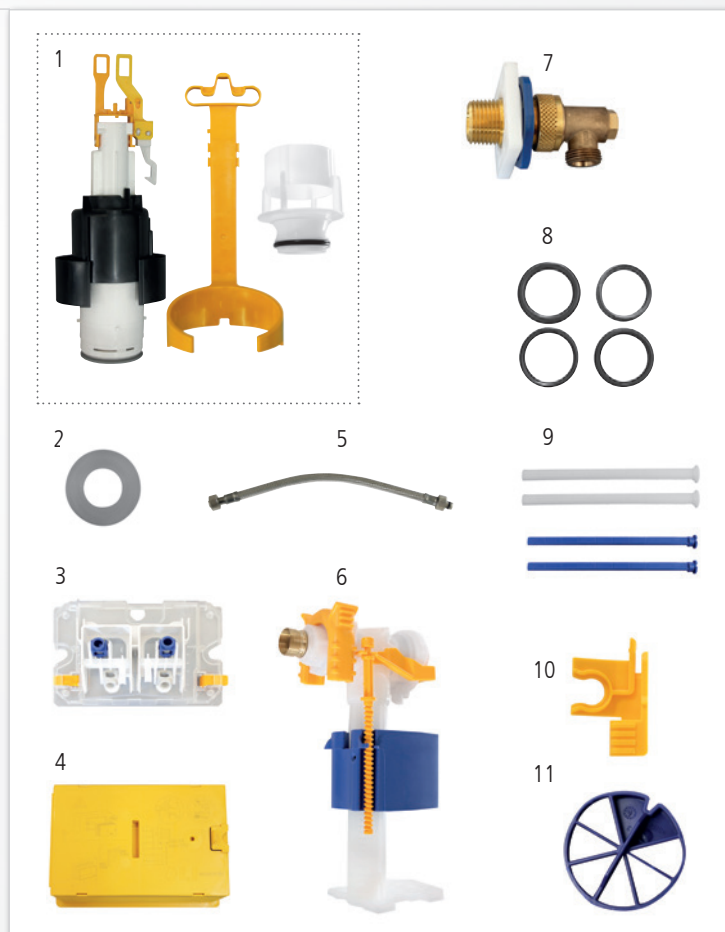

Cisterns

Description

Concealed cistern K770
Actuation from the front



Suitable flush buttons for K770:



Ref. no.

1	Burda drain valve incl. basin and hold-down device	935014
2	Burda drain valve seal	935002
3	Burda bearing block	936004
4	Burda filling valve hose	935007
5	Burda filling valve with holder	935008
6	Burda angle valve	935009
7	Burda stowage insert to K760/K770	935011
8	Burda universal sealing kit for flush pipe bend	970010
9	Burda filling valve holder	935005
10	Extension bolt flush button	935013
11	Bolt quick-release fastener	936005
12	Pusher bolt	936007
13	Burda flush button T790 white matt chrome finish polished chrome finish	790.00 790.50 790.51
14	Burda flush button T795 white matt chrome finish polished chrome finish	795.00 795.50 795.51
15	Burda flush button T785, stainless steel	785.60

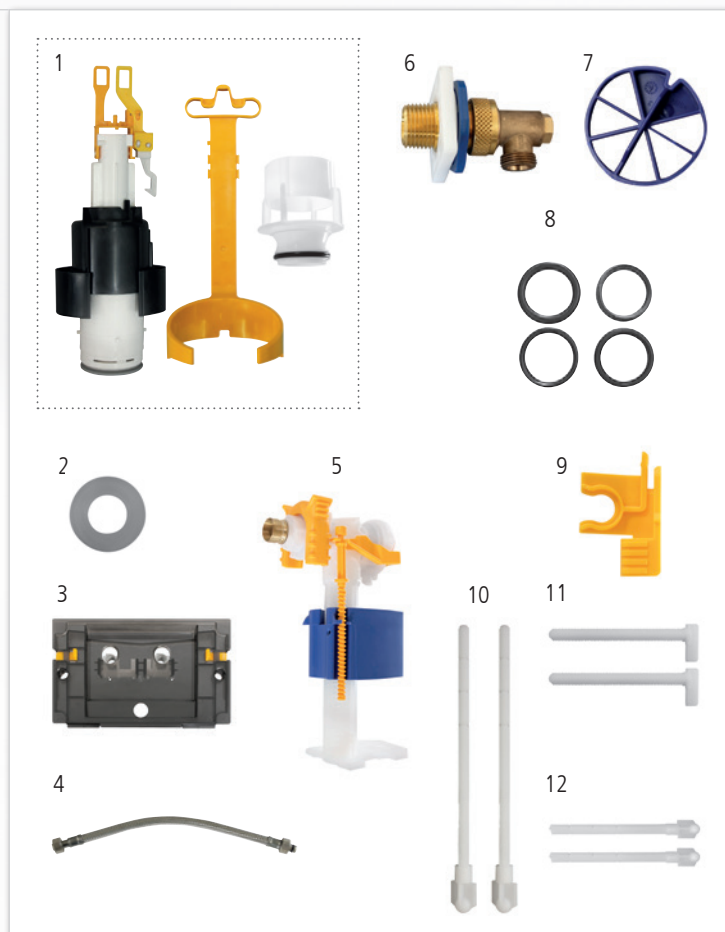

Cisterns

Description

Concealed cistern K921/K951/K961
Actuation from above or from the front



Suitable flush buttons:



Ref. no.

1	Burda drain valve complete incl. basin with seal, water level rod and holder with lung	930004
2	Burda drain valve seal	930019
3	Burda construction protection	930017
4	Burda filling valve hose	930002
5	Burda filling valve holder	930016
6	Burda filling valve	930013
7	Burda hose set	930014
8	Bolt quick-release fastener	934011
9	Burda universal sealing kit for flush pipe bend	970010
10	Burda eccentric fastening for spacer bolts (2 pcs.)	934007
11	Burda rear fixing plate	930015
12	Burda flush button T921, white matt chrome finish polished chrome finish	921.00 921.50 921.51

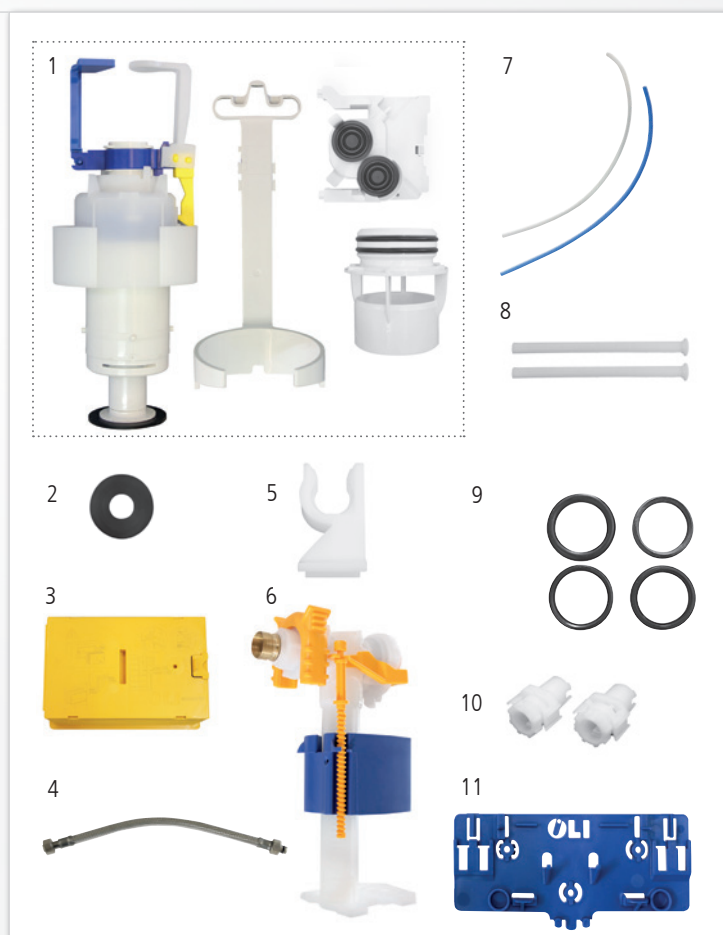

Cisterns

Description

Concealed cistern Geberit Delta (UP100/Basic)
Actuation from the front



Suitable Geberit flush buttons:

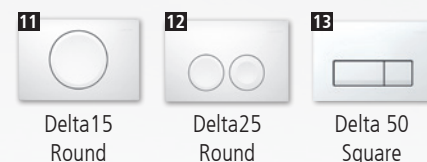

Ref. no.

1	Geberit protective plate	952001
2	Geberit building protection, without accessories	952002
3	Geberit universal filling valve type 383 (new from 2025)	950009
4	Geberit bearing block	952003
5	Geberit armoured hose type 383 (new from 2025)	950042
6	Geberit drain valve incl. basin (new from 2022)	950058
7	Geberit drain valve seal	950016
7a	Geberit drain valve seal (new from 2022)	950017
8	Geberit angle valve	950049
9	Burda universal sealing kit for flush pipe bend	970010
10	Wall-mounted WC connection set DN80	950080
11	Geberit flush button Delta15 Round white matt chrome finish	550026.00 550026.50
12	Geberit flush button Delta25 Round white matt chrome finish	550042.00 550042.50
13	Geberit flush button Delta50 Square white matt chrome finish	550066.00 550066.50



Cisterns

Description

Concealed cistern Geberit Kappa (UP200)
Actuation from above or from the front



Suitable flush buttons:



Ref. no.

1	Geberit building protection, without accessories	950022
2	Geberit armoured hose type 383 (new from 2025)	953005
3	Geberit universal filling valve type 383 (new from 2025)	950009
4	Geberit bearing block	951002
5	Geberit lifting bell complete with basin	951005
6	Geberit water connection complete	951004
7	Geberit protective plugs	950019
8	Universal sealing kit for flush pipe bend	970010
9	Wall-mounted WC connection set DN80	950080
10	Geberit flush button Kappa20 white	550048.00
11	Geberit flush button Kappa21 Plate and button polished chrome finish Design rings matt chrome finish	550049.65
	Plate and button white Design rings polished chrome finish	550049.83

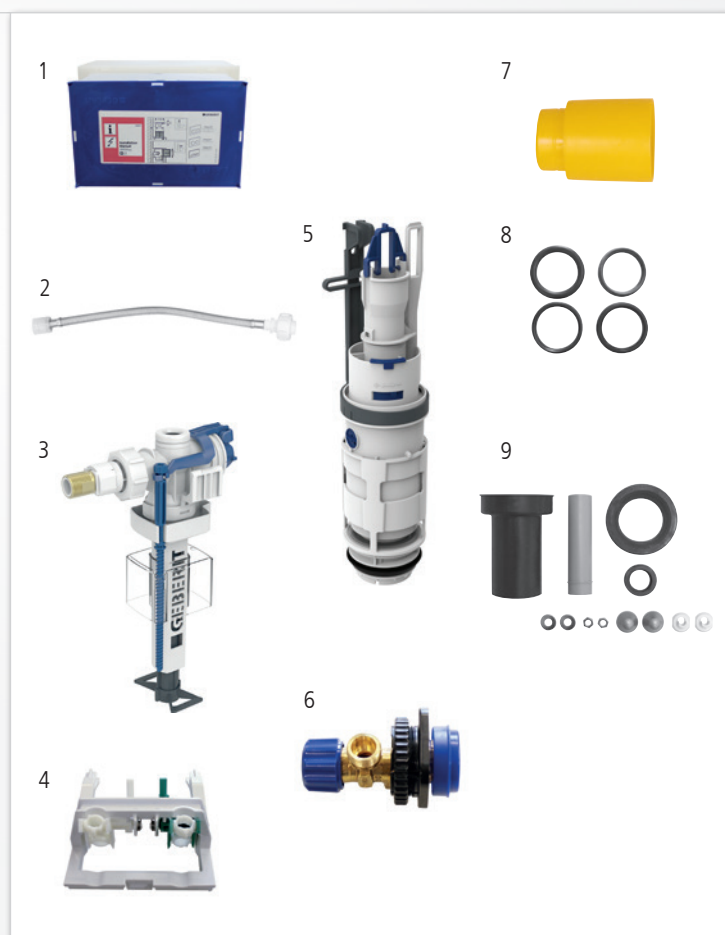

Cisterns

Description

Concealed cistern Geberit Sigma (UP320)
Actuation from the front



Suitable flush buttons:

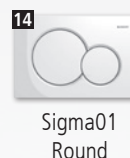

Ref. no.

1	Geberit protective plate	950073
2	Geberit building protection, without accessories	950074
3	Geberit bearing block	950075
4	Geberit universal filling valve type 383 (new from 2025)	950009
5	Geberit Filling valve holder	950046
6	Geberit armoured hose type 383 (new from 2025)	950042
7	Geberit water connection with shut-off valve	950049
8	Geberit drain valve complete incl. basin (new from 2022)	950058
9	Geberit drain valve seal	950016
9a	Geberit drain valve seal (new from 2022)	950017
10	Universal sealing kit for flush pipe bend	970010
11	Geberit protective plugs	950019
12a	PE wall-mounted WC drain elbow DN90 with Reducer DN100, depth-adjustable for BS+	950131
12b	PE wall-mounted WC drain elbow DN90 with Reducer DN100, depth-adjustable for Kombiset	950132
13	Wall-mounted WC connection set DN90	950080
14	Geberit flush button Sigma01 Round	
	white	551030.00
	matt chrome finish	551030.50
	polished chrome finish	551030.51

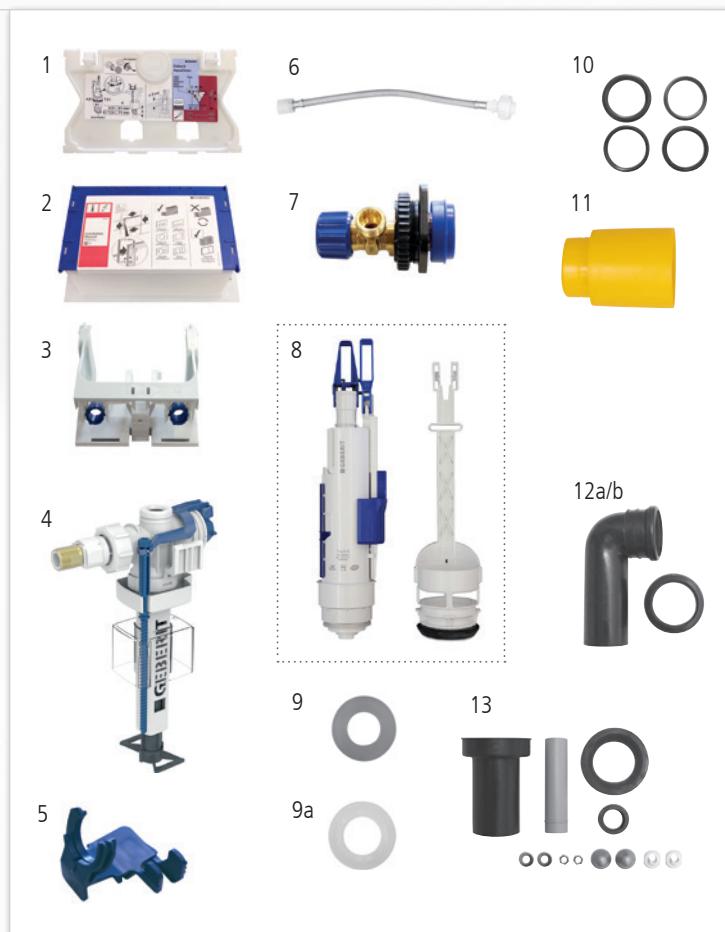

Cisterns

Description

Concealed cistern Geberit Omega
Actuation from above or from the front



Suitable flush buttons:

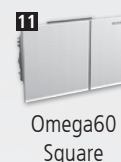

Ref. no.

1	Geberit protective plate	953060
2	Geberit bearing block	953002
3	Geberit drain valve complete	950058
4	Geberit universal filling valve type 383 (new from 2025)	950009
5	Geberit armoured hose type 383 (new from 2025)	953005
6	Geberit building protection, without accessories	953022
7	Universal sealing kit for flush pipe bend	970010
8	Geberit water connection complete	953004
9	Geberit flush button Omega20 Round	
	polished chrome finish, Design rings matt chrome finish	550060.65
	white, Design rings polished chrome finish	550060.83
	white, Design rings gold-plated	550060.66
	black, Design rings polished c	550060.84
10	Geberit flush button Omega20 Square	
	polished chrome finish, Design rings matt chrome finish	550061.65
	white, Design rings polished chrome finish	550061.83
	white, Design rings gold-plated	550061.66
	black, Design rings polished chrome finish	550061.84
11	Geberit flush button Omega60 Square	
	Brushed chrome-plated, design strips and frame polished chrome finish	550062.87
	glass white, design strips mirrored frame polished chrome finish	550062.69

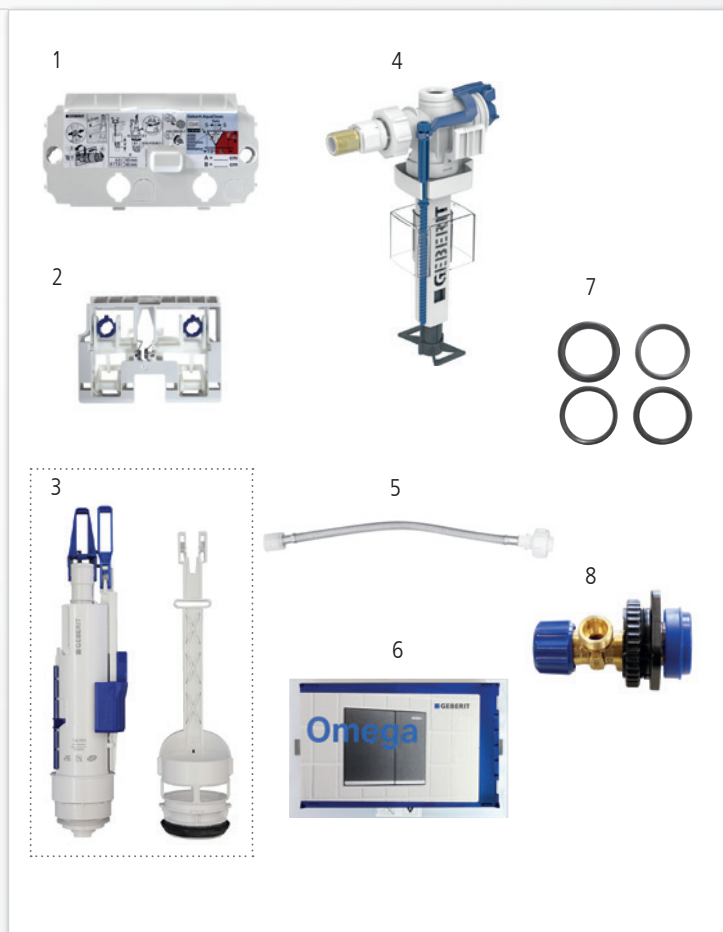

Cisterns

Description

Concealed cistern „Angel“ 6 – 9 ltr.
Actuation from the front (VALSIR)

Suitable
flush buttons:



Z1100

Ref. no.

1	Drain valve	506056
2	Drain valve seal	506058
2a	Drain valve seal (old)	504383
3	Basin with seal	506059
4	Pneumatic set	506063
5	Connecting hose	506055
6	Revision plate	504628
7	Filling valve incl. holder	506054
8	Bracket with rocker (old)	506061
9	Bracket with rocker (new)	506062
10	Universal sealing kit for flush pipe bend	970010
11	Extension set	504637
12	Angle valve	504620
13	Fastening screws for building protection	504627
14	Water level rod	504624
15	Bearing block complete	506060
16	Hook for removing from the basin	504640
17	Bracket for spacer bolts (2 pcs.)	504634
18	Clips (2 pcs.)	504635
19	Spacer bolt (2 pcs.)	504636
20	Handle bar	504629
21	Flush button, 1-quantity, white	Z1100

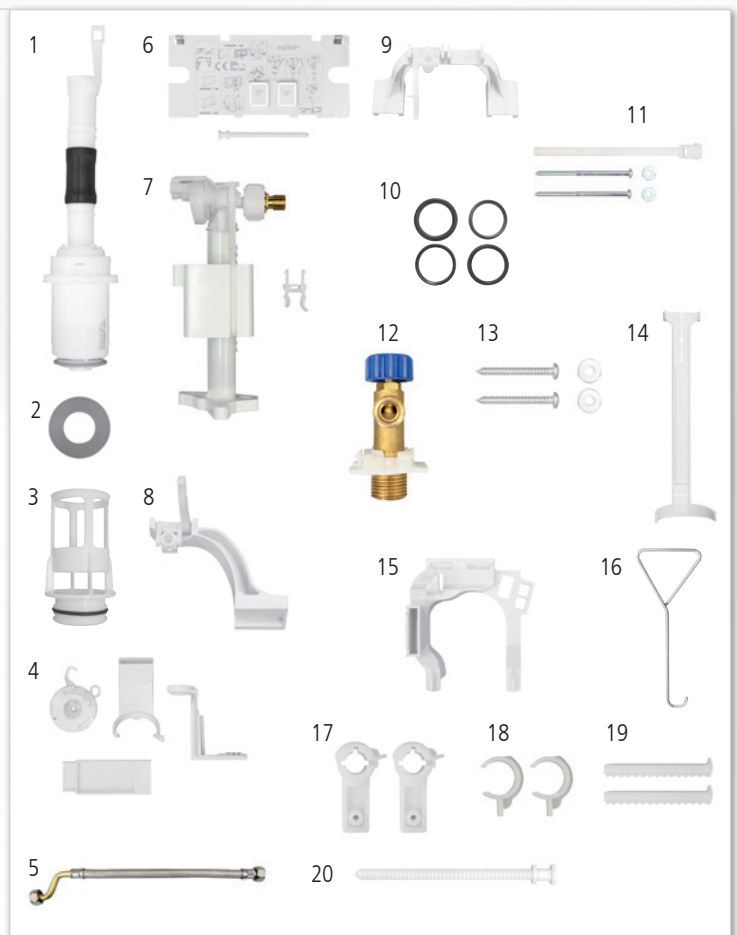

Cisterns

Description

Concealed cistern „Angel 2“ 3–6 ltr.or 4,5–9 ltr.
Actuation from the front (VALSIR)

Suitable
flush buttons:



Z1200

Ref. no.

1	Drain valve	506064
2	Drain valve seal	506058
2a	Drain valve seal (old)	504383
3	Basin with seal	506059
4	Connecting hose	506055
5	Revision plate	504628
6	Filling valve incl. holder	506054
7	Angle valve	504620
8	Bracket with rocker	506069
9	Extension set	506116
10	Universal sealing kit for flush pipe bend	970010
11	Bearing block complete	506060
12	Fastening screws for building protection	504627
13	Water level rod	504624
14	Hook for removing from the basin	504640
15	Spacer bolt (2 pcs.)	504636
16	Handle bar (small flush volume)	506068
17	Bracket for spacer bolts (2 pcs.)	504634
18	Clips (2 pcs.)	504635
19	Handle bar (large flush volume)	504629
20	Flush button, 2 quantity, white	Z1200
	Flush button, 2 quantity, matt chrome finish	Z1201

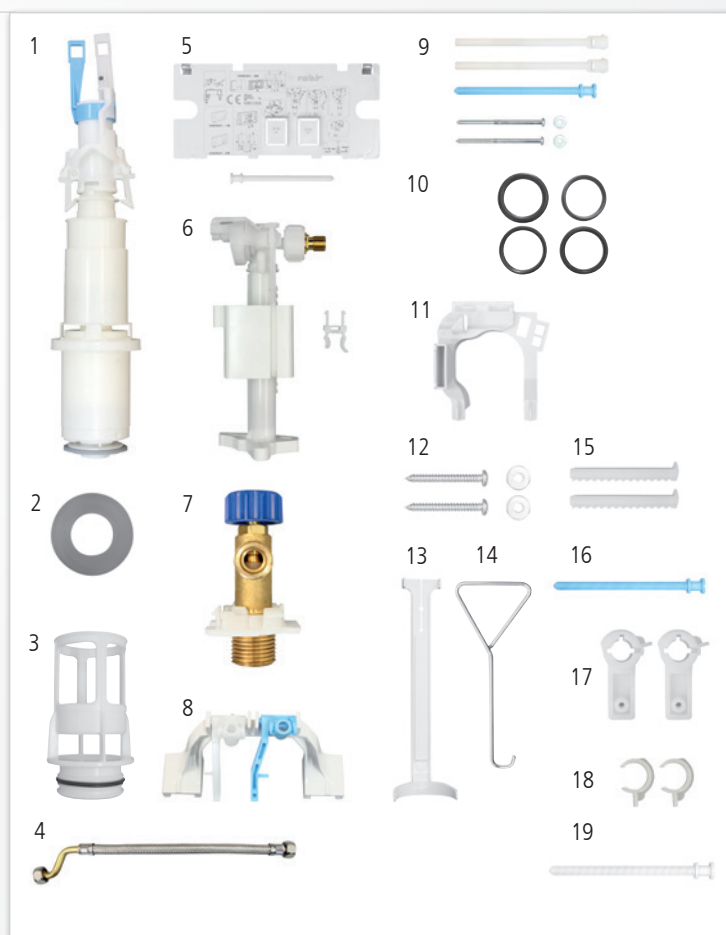

Cisterns

Description

Concealed cistern Egea 6 ltr.
Actuation from above or from the front (VALSIR)

Suitable
flush buttons:



Z1150

Ref. no.

1	Drain valve	506070
2	Seal for drain valve	506058
3	Basin with seal	506059
4	Pneumatic set	506074
5	Connecting hose	504639
6	Filling valve incl. holder	506054
7	Angle valve	504620
8	Bracket with rocker	504049
9	Handle bar	504646
10	Building protection	504645
11	Universal sealing kit for flush pipe bend	970010
12	Protective plugs	175296
13	Hold-down device	504644
14	Bearing block complete	504647
15	Hook for removing from the basin	504640
16	Bracket for spacer bolts (2 pcs.)	504634
17	Clips (2 pcs.)	504635
18	Spacer bolt (2 pcs.)	504636
19	Extension set	504637
20	Flush button, 1-quantity, white	Z1150
	Flush button, 1-quantity, matt chrome finish	Z1151



Infrared urinal controls

Description

Infrared single urinal control

BurdaTronic U-01, 230 V

BurdaTronic U-04, 230 V



BurdaTronic U-01



BurdaTronic U-04

Successor model
BurdaTronic U-09
see page 27

Ref. no.

1	Shut-off valve	503846
2	Magnetic valve 24V	998608

Note:

All old urinal flush controls U-01 and U-04, 230 V fits the successor model U-09, 230 V, stainless steel (see page 27)



no longer available

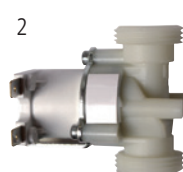

no longer available

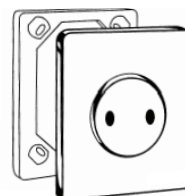

Old cover U-01



no longer available



Urinal control Flowtronik

Description

Ref. no.

Flowtronik prefabricated set neu, Bluetooth
for installation in Burda Flowtronik shell set

214 854

1	Flowtronik shell set	214755
2	Flowtronik electronic box from 01/2014	214876
3	Flowtronik magnetic valve	214861
4	Flowtronik sensor trap DN 50	214886

Spare parts for 3-pin plug connection
Trap / control unit no longer available.
In this case, order Flowtronik prefabricated kit
from 01/2014

214854

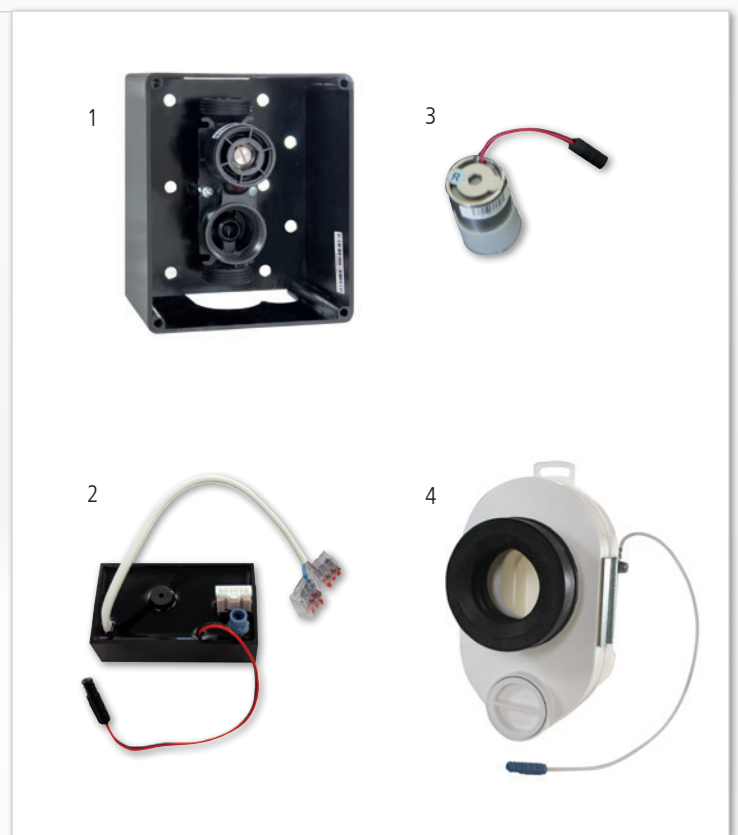

Urinal trap controls

Description

Ref. no.

**BurdaTronic U-03 prefabricated set, 230 V
Trap control **from 2016****

Z74

Ref. no.

Z74 Prefabricated set

Z74

The following components are also available individually

- | | | |
|---|---|--------|
| 1 | Z74 Magnetic valve + adapter | 214863 |
| 2 | Z74 Sensor trap DN 50 | 214886 |
| 3 | Z74 Electronic box | 214876 |
| 4 | Z74 Sensor trap DN 50 with extended Connection cable (2 metres) | 214888 |

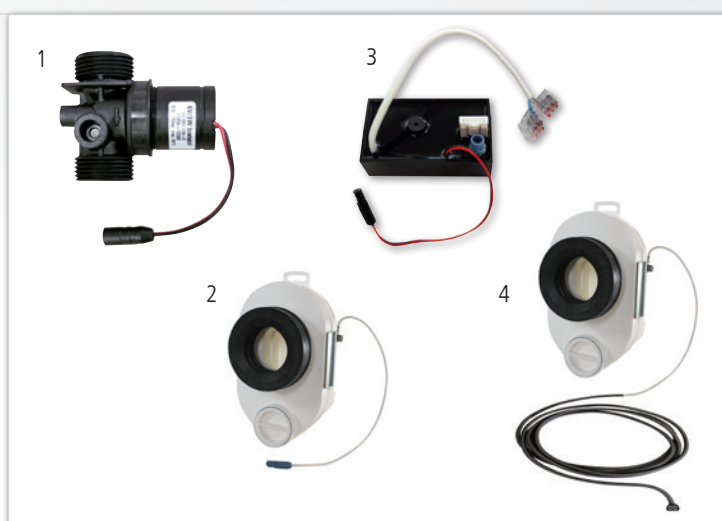

Description

Ref. no.

**BurdaTronic U-03 prefabricated set, 230 V
Trap control**

Z73

Control unit and sensor siphon no longer available. If required, the complete successor set Z74 (see above) must be used

Ref. no.

The following components are still available individually

- | | | |
|---|---|--------|
| 1 | BurdaTronic U-03 siphon adapter for use with vertical outlet (optional) (e.g. Keramag, Laufen, Taro Nova) | 231311 |
| 3 | BurdaTronic U-03 magnetic valve | 998608 |



Urinal flush controls Conversion kit radar to Flowtronik

Description

Ref. no.

Conversion kit for Radar MC FL ready kit Z85 to Burda Flowtronik

Z86

Ref. no.

Z86

Radar MC FL ready-to-use set Z85 is no longer available! In this case, the conversion must be carried out using conversion kit Z86 from Radar to Burda Flowtronik must be used.



You can find the appropriate installation instructions at <https://burda-online.com/wp-content/uploads/2023/02/Radar-auf-Burda-Flowtronik.pdf>

Infrared urinal control

Description

BurdaTronic U-09, 230 V

Ref. no.

505455.60



Ref. no.

- | | | |
|---|-------------------------------------|--------|
| 1 | Shell set | 214755 |
| 2 | Trafo, 230V * | 214877 |
| 3 | Flowtronik magnetic valve + adapter | 214863 |
| 4 | Remote control | 505556 |

***Note:** For versions from 2019, the transformer is included in the control unit (no separate component)

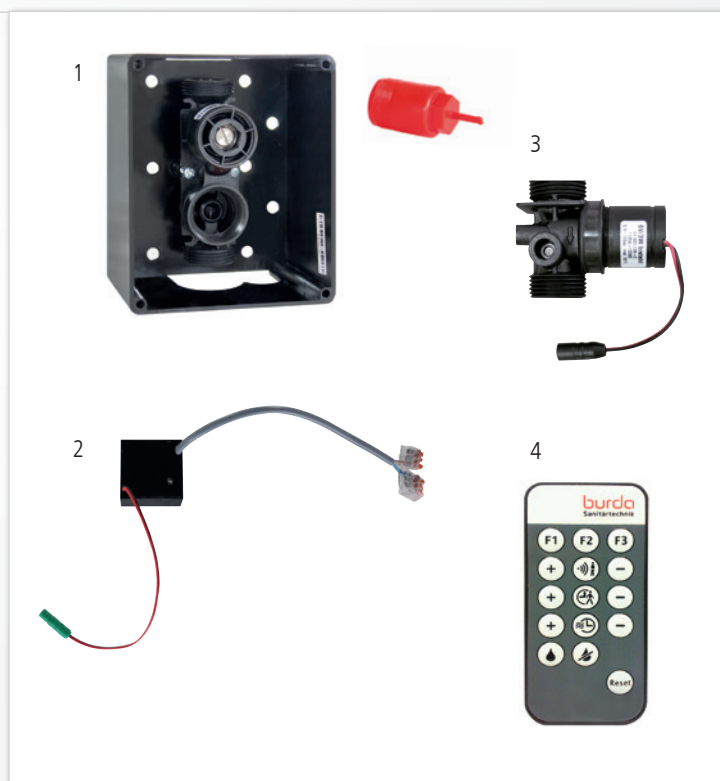



burda
Sanitärtechnik

Herbert Burda GmbH
Krefelder Straße 87
40549 Düsseldorf

Tel. 0211 95001-0
Fax. 0211 50 05 75

www.burda-online.com